

\$ git branch

\$ git logs

# GIT CHEAT SHEET

\$ git fetch

\$ git status

## SETUP & INIT

Configuring user information, initializing and cloning repositories.

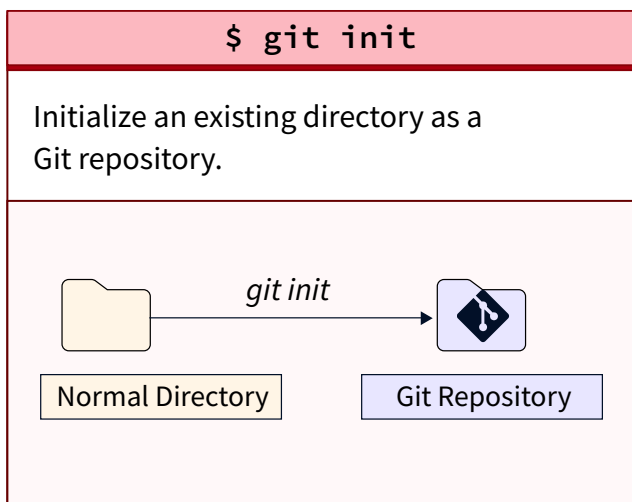

## STAGE & SNAPSHOT

Working with snapshots and the Git staging area.

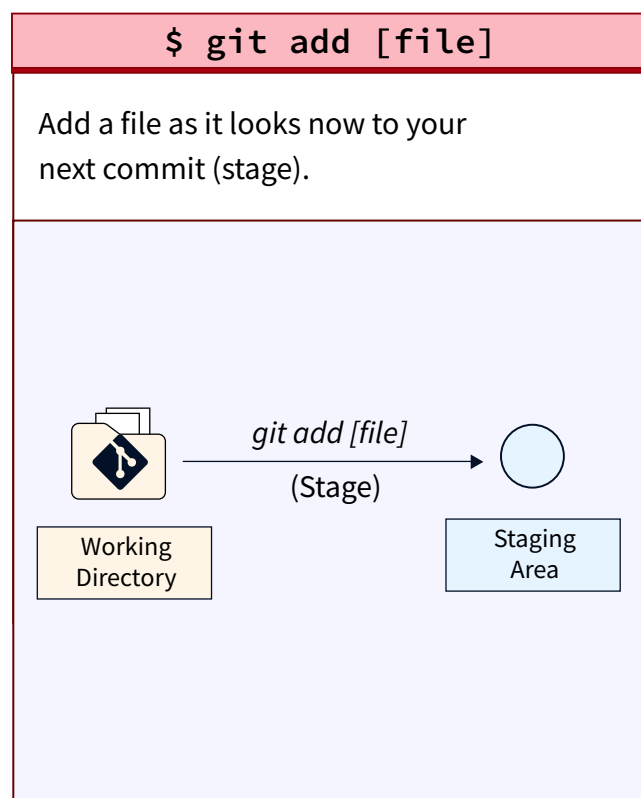
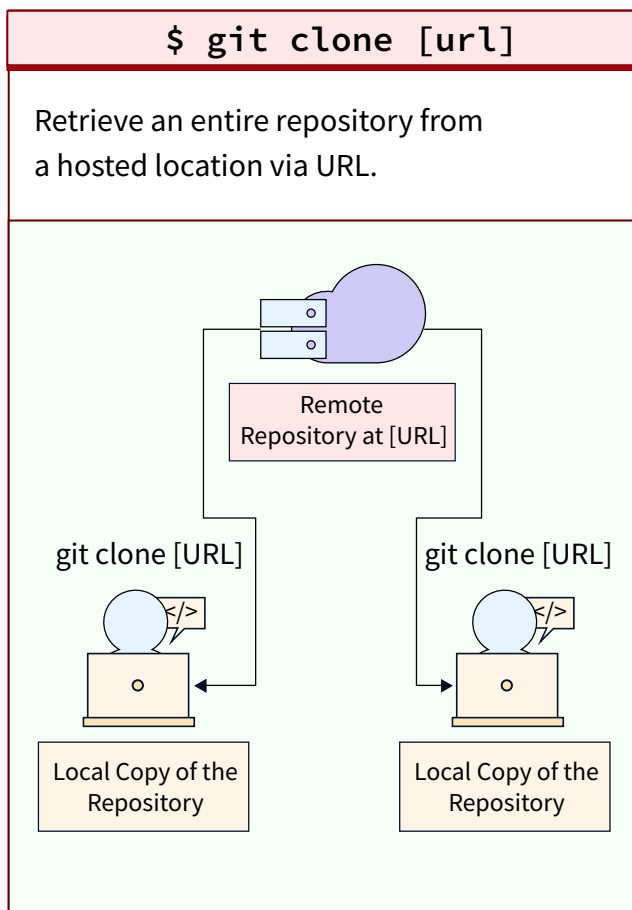
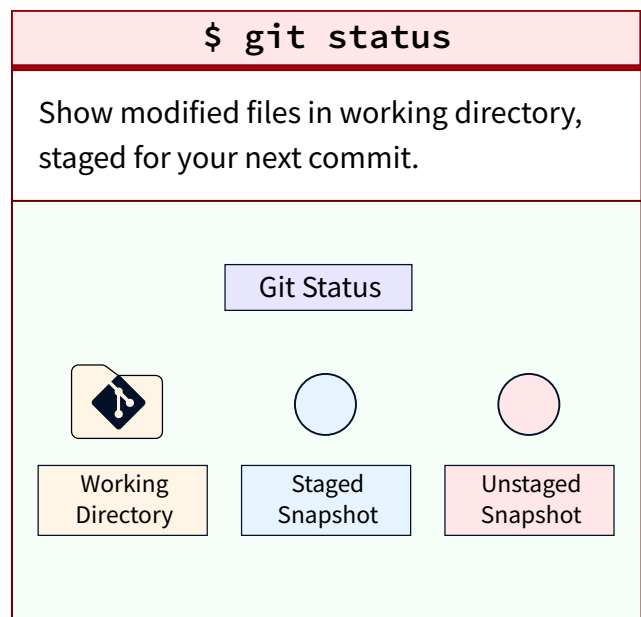

## \$ git reset [file]

Unstage a file while retaining the changes in working directory.

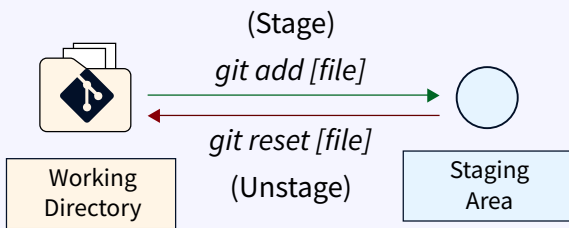

## \$ git commit -m "[descriptive message]"

Commit your staged content as a new commit snapshot.

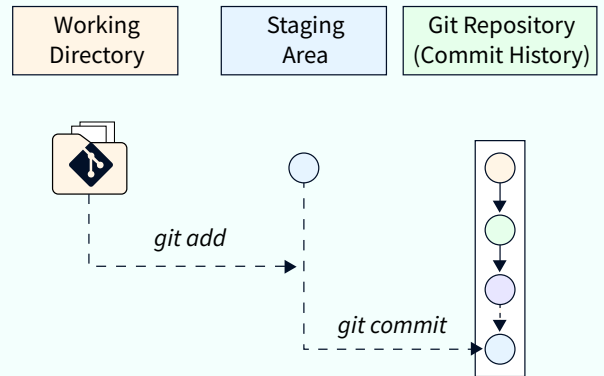

## \$ git diff

Diff of what is changed but not staged



## BRANCH & MERGE

Isolating work in branches, changing context, and integrating changes.

## git diff --staged

Diff of what is staged but not yet committed.

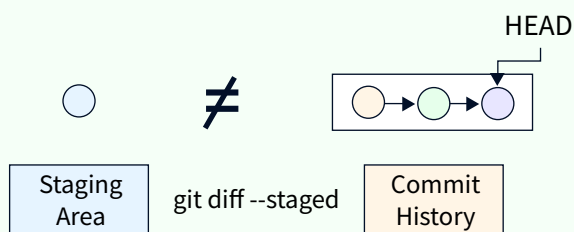

## \$ git branch

List your branches. A \* will appear next to the currently active branch.

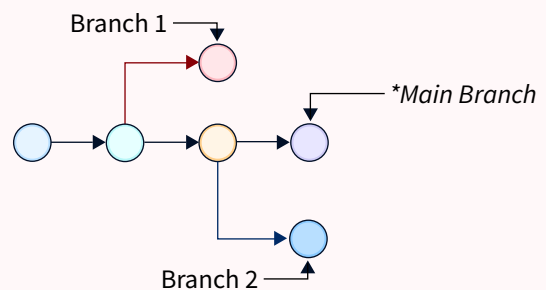

## \$ git branch [branch-name]

Create a new branch at the current commit.

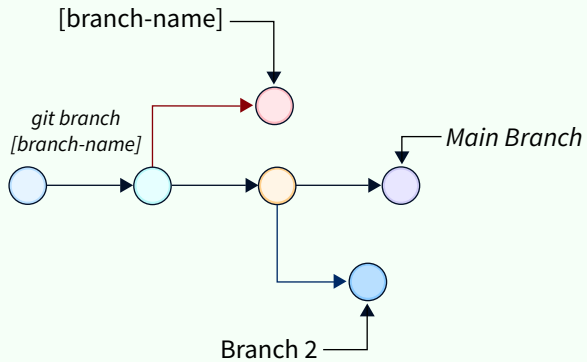

## \$ git merge [branch]

Merge the specified branch's history into the current one.

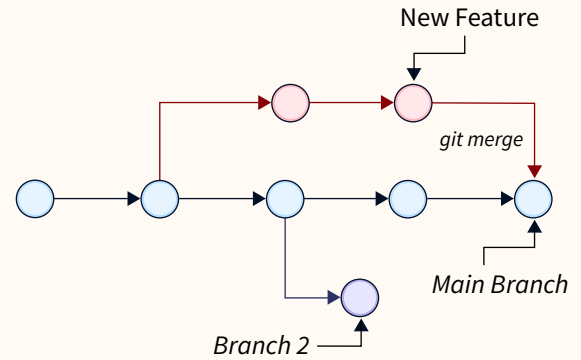

## \$ git checkout

Switch to another branch and check it out into your working directory.

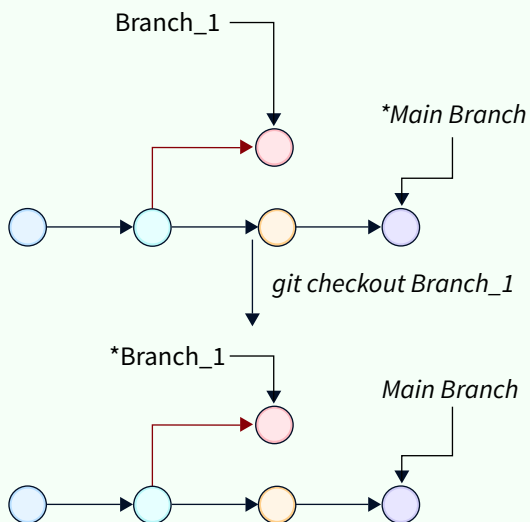

## \$ git log

Add a file as it looks now to your next commit (stage).

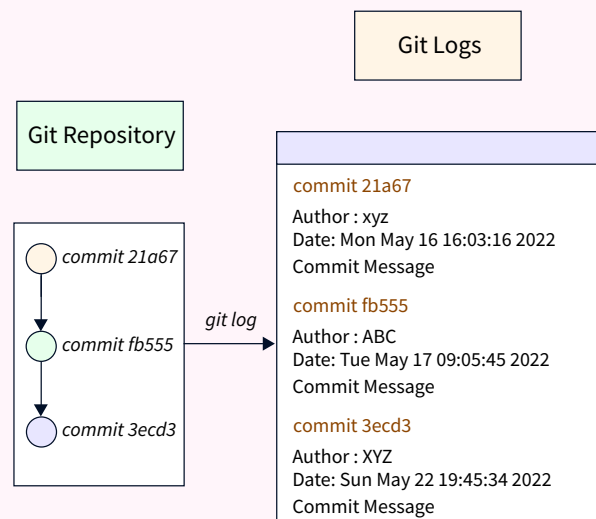

# INSPECT & COMPARE

Configuring user information, initializing and cloning repositories.

## \$ git log branchB..branchA

Show the commits on branchA that are not on branchB.

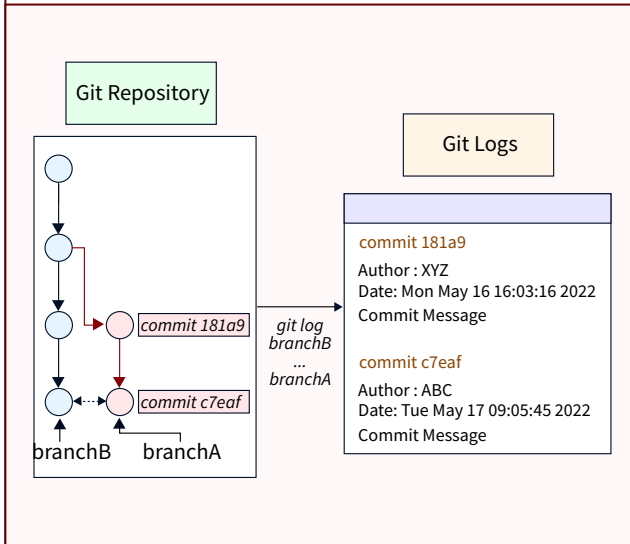

## \$ git diff branchB...branchA

Show the diff of what is in branchA that is not in branchB.

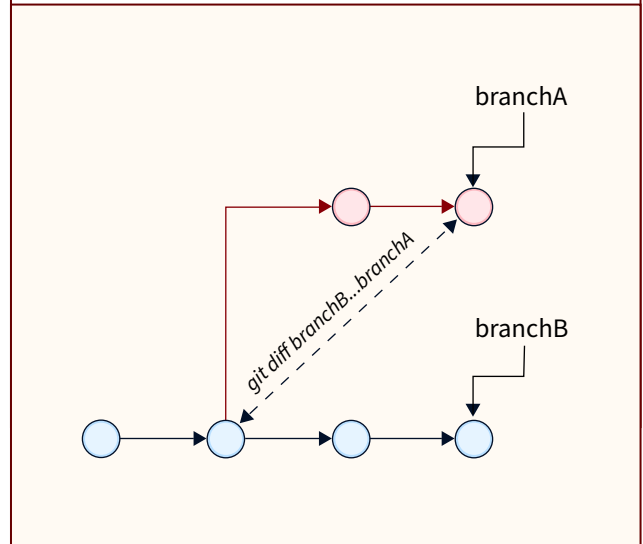

## \$ git log --follow [file]

Show the commits that changed file, even across renames.

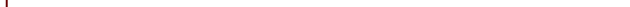

## \$ git show [SHA]

Show any object in Git in human-readable format.

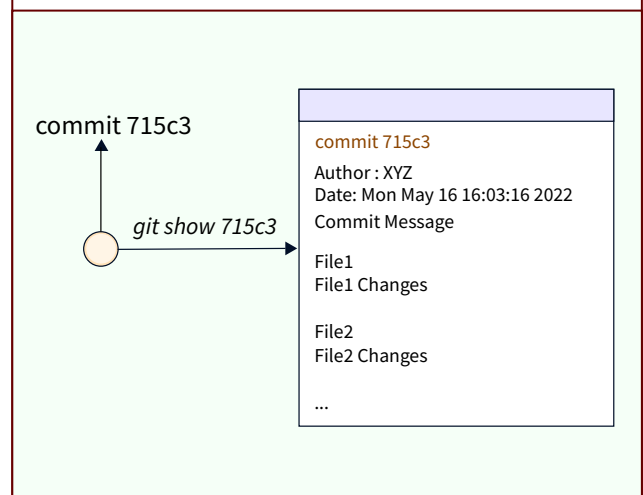

## TRACKING PATH CHANGES

Versioning file removes and path changes.

```
$ git rm [file]
```

Delete the file from the project and stage the removal for commit.



Git Repository

```
$ git mv [existing-path] [new-path]
```

Change an existing file path and stage the move.

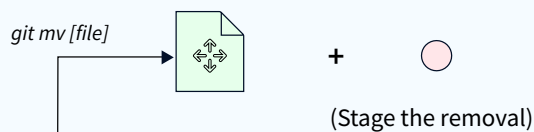

Git Repository

```
$ git log --stat -M
```

Show all commit logs with indication of any paths that moved.

## IGNORING PATTERNS

Preventing unintentional staging or committing of files.

```
logs/  
*.notes  
pattern*/
```

Save a file with desired patterns as `.gitignore` with either direct string matches or wildcard globs.

`.gitignore`

```
logs/  
*.notes  
pattern*/
```

```
$ git config --global core.excludesfile [file]
```

System wide ignore pattern for all local repositories

## SHARE & UPDATE

Retrieving updates from another repository and updating local repos.

**\$ git remote add [alias] [url]**

Add a git URL as an alias.

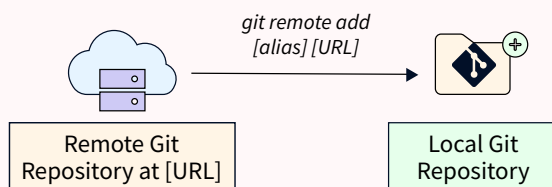

**\$ git merge [alias]/[branch]**

Merge a remote branch into your current branch to bring it up to date.

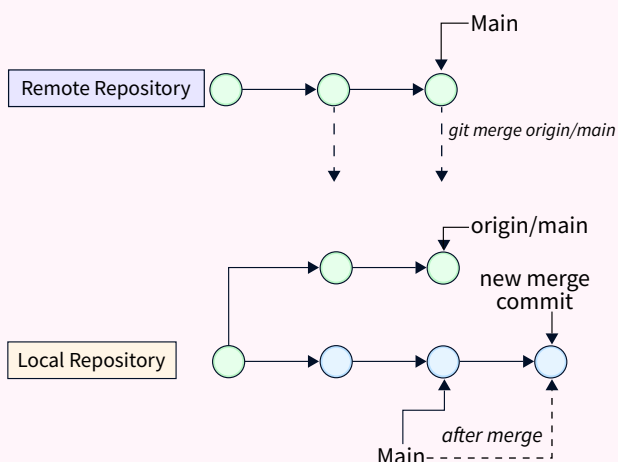

**\$ git fetch [alias]**

Fetch down all the branches from that Git remote.

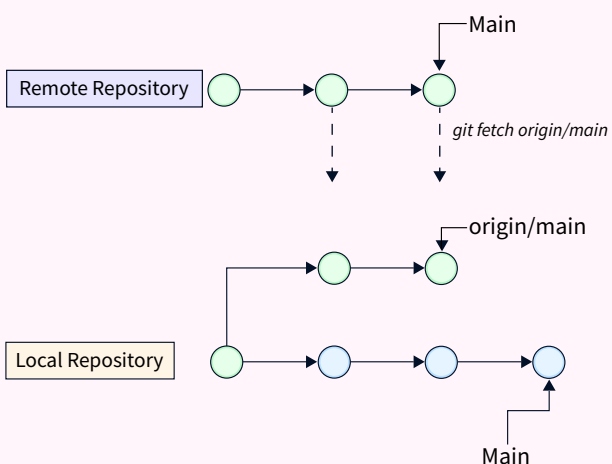

**\$ git push [alias] [branch]**

Transmit local branch commits to the remote repository branch.

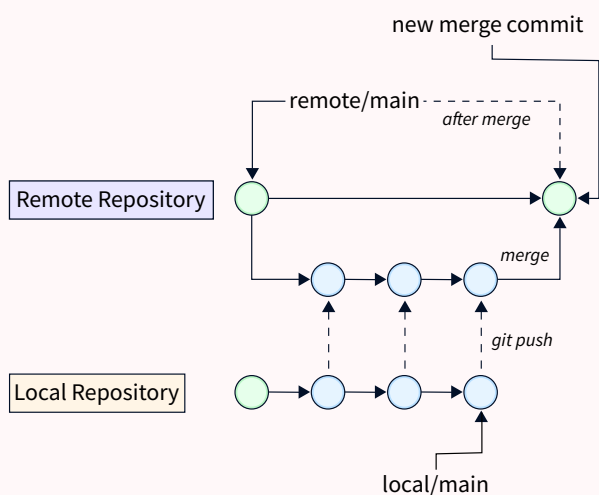

## \$ git pull

Fetch and merge any commits from the tracking remote branch.

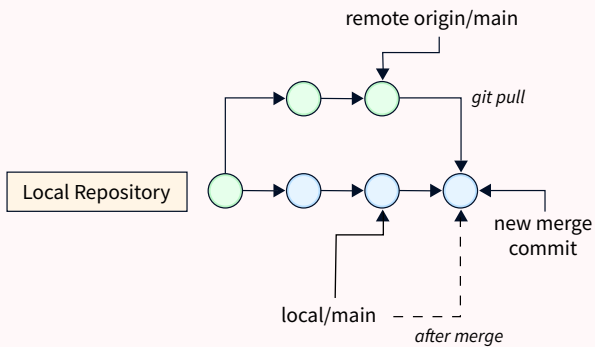

## \$ git reset --hard [commit]

Clear staging area, rewrite working tree from specified commit.

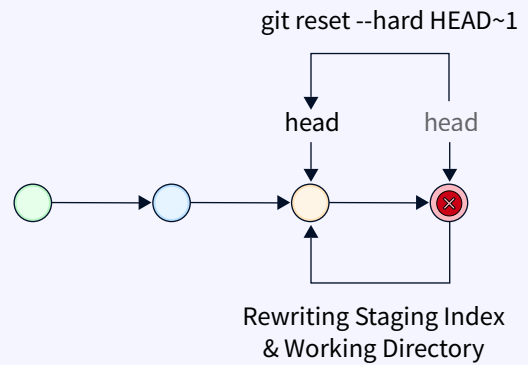

## REWRITE HISTORY

Rewriting branches, updating commits and clearing history.

### \$ git rebase [branch]

Apply any commits of the current branch ahead of specified one.

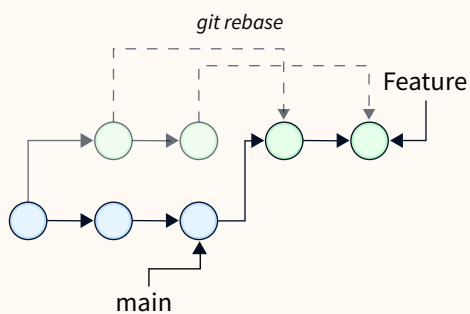

## TEMPORARY COMMITS

Temporarily store modified, tracked files in order to change branches.

### \$ git stash

Save modified and staged changes.

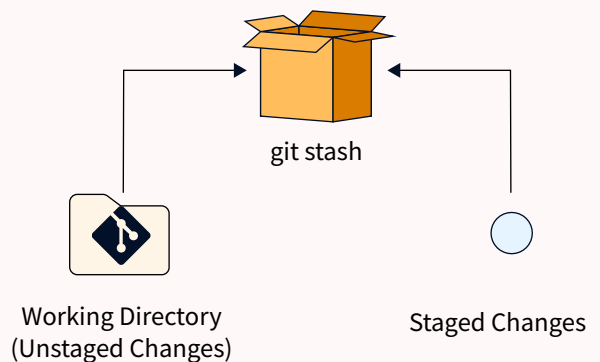



## \$ git stash list

List stack-order of stashed file changes.

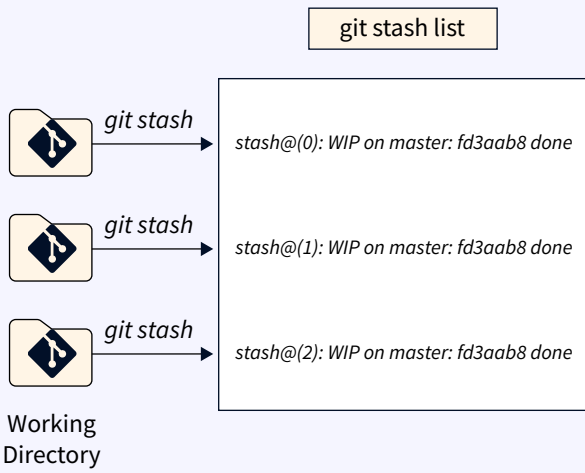

## \$ git stash pop

Write working from the top of the stash stack.

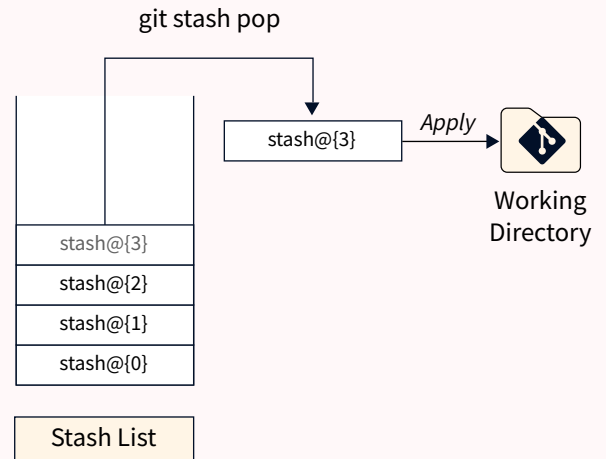

## \$ git stash drop

Discard the changes from the top of the stash stack.

